



## Restroom Cubicle And Partition

---

Quality | Satisfaction | Teamwork

[www.restcube.in](http://www.restcube.in)



<b>01</b>	<b>About our Company</b>	Page No. 03
<b>02</b>	<b>Our Product &amp; Cubicle Series</b>	
	RC- Smart Nylon	Page No. 06
	RC - Versatile Combo	Page No. 07
	RC - Dynamic SS	Page No. 08
	RC - Titanium ShoeBox	Page No. 09
	RC - Titanium Ceiling Hung	Page No. 10
	RC - Flouter	Page No. 12
	RC - SS Pipe Glance	Page No. 14
	RC - Kids Cube	Page No. 15
	RC - PD Door	Page No. 17
<b>03</b>	<b>Urinal Partition (UMP)</b>	Page No. 18
<b>04</b>	<b>Lockers</b>	Page No. 20
<b>05</b>	<b>Clients</b>	Page No. 22
<b>06</b>	<b>Color Shades</b>	Page No. 23

# ABOUT US

Our business and our reputation are built on the quality of our design, our local manufacturing expertise and our customer care. Working with architects and designers, we create toilet and shower cubicles that function beautifully, and provide lasting style and elegance. The product line of Toilet Cubicles, Changing Room Toilet Cubicle, Mall Toilet Cubicle Partition, School Toilet Cubicle Partition, Ceiling Hung Model Bathroom Cubicle, Flexible Toilet Cubicle Partition, Shower Cubical Fitting, Commercial Toilet Cubicle etc., that we offer are a perfect combination of cutting-edge innovation, excellent performance and great aesthetics; all that are available to satisfy the most basic needs of humans. Carefully designed to fit as per the users requirements, both in terms of visual appeal and functionality; our cubicles and fittings are highly demanded in various sectors

## WHY CHOOSE US...

**Apart from being assured of outstandingly beautiful results, there are many other reasons why you should consider choosing us**

### **High performance**

In the detailing and engineering of all our Toilet Cubicle Partition, we bring a high level of quality visually and technically. We incorporate modern building systems together with age old joinery techniques, creating spaces that fuse elegance and beauty with high performance efficiency

### **Market Leader in toilet partitions**

Throughout the years, Scranton Products has developed new products using HPL including lockers, bathroom partitions, shower cubicle, urinal partition, dressing room. These product introductions were designed to provide products that perform better in their applications than traditional materials while providing improved aesthetics and lower maintenance

### **Cost effective**

Our clients often tell us that when comparing like for like we offer the most competitive pricing in timber frame and oak frame design and construction.

### **Professional service**

Working closely with engineers, architects and various timber frame industry specialists, our team provides imaginative and uniquely detailed structures.

### **Market Leader in toilet partitions**

Throughout the years, Scranton Products has developed new products using HPL including lockers, bathroom partitions, shower stalls, benches, dressing compartments and vanity tops. These product introductions were designed to provide products that perform better in their applications than traditional materials while providing improved aesthetics and lower maintenance



# HPL Laminated Board Sheet

## Technology at work

The High Pressure Laminated boards, conforming to IS: 20146, are manufactured under a special process and a strict quality control regimen. The board is made out of cellulosic material whereas its core is made of layers of cellulose which are impregnated with thermosetting phenolic resin. The decorative design paper on either side of the board is impregnated with special melamine resin. This is manufactured under a very high temperature and a high pressure in a multi-daylight press in which resin polycondensation takes place to give the end product the desired extra toughness and durability.



Tissue overlay (for print decors)  
Impregnated with melamine resin

Solid or print design paper layer  
Impregnated with melamine resin

Jet black colour kraft paper layer  
Impregnated with phenolic resin

Solid or print design paper layer  
Impregnated with melamine resin

Tissue overlay (for print decors)  
Impregnated with melamine resin

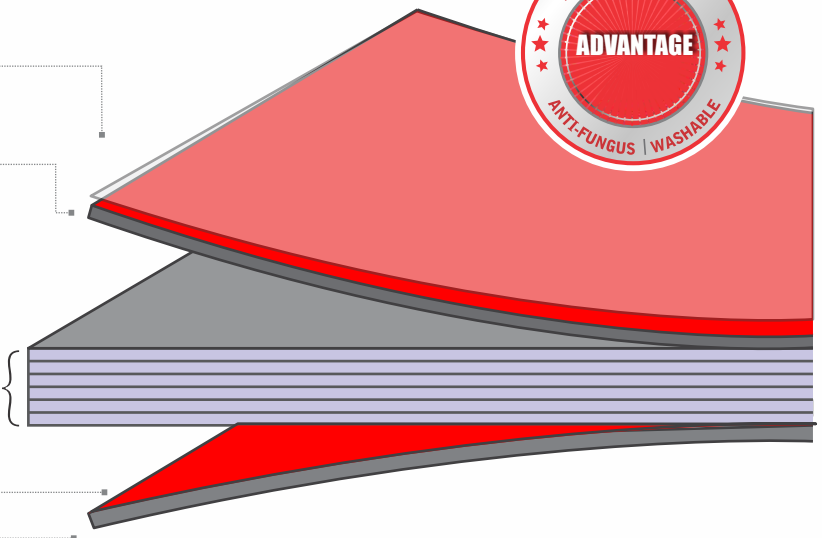

Scratch Resistant



Quick Installation



Solvent Resistant



Impact Resistant



Environment Friendly



Moisture Resistant



Resistant to Cigarette Burns



Hygienic & Safe

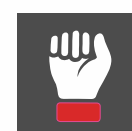

Durable



Easy to maintain

## Used In



Sports, Stadium,  
Gym, etc



Restuarants,  
Hotels, etc



Schools-Colleges,  
Hospital, etc



Mall, Offices,  
Theaters, etc

### EU-Enclosed Unit

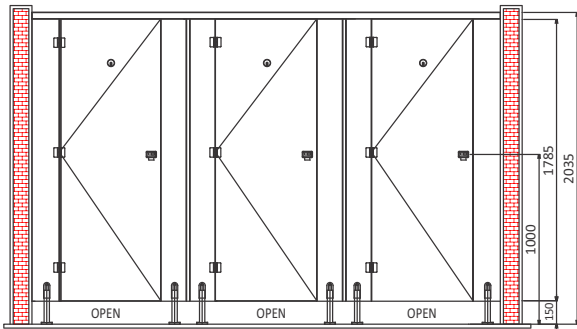

Front View (EU)

### CU-Corner Unit

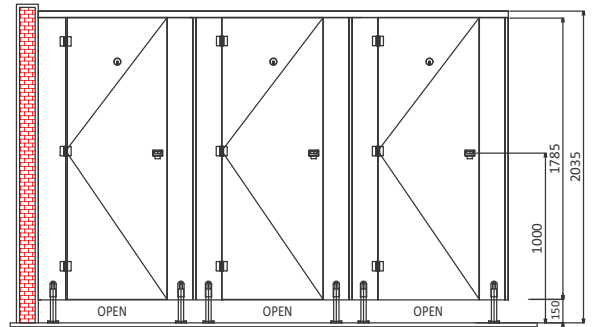

Front View (CU)

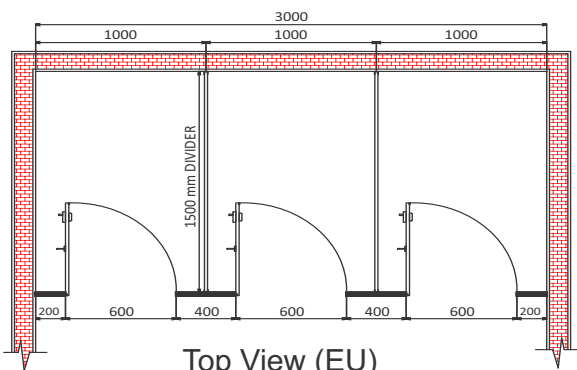

Top View (EU)

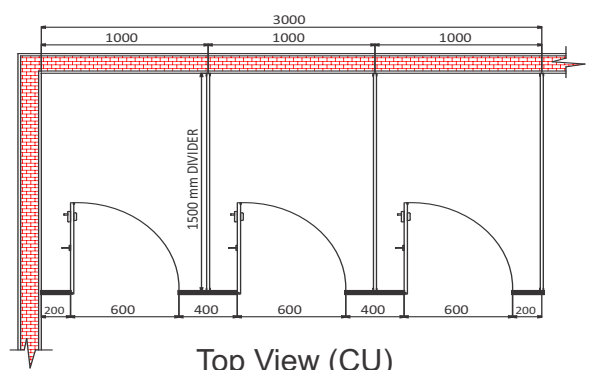

Top View (CU)

## Hardware Detailing

Each restroom cubicle is equipped with the following set of hardware fittings:



U Channel Rail

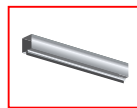

Head / Top Rail



Coat Hook



Privacy Thumb-Turn with Indicator



Door Knob



Gravity Hinge



Adjustable Foot

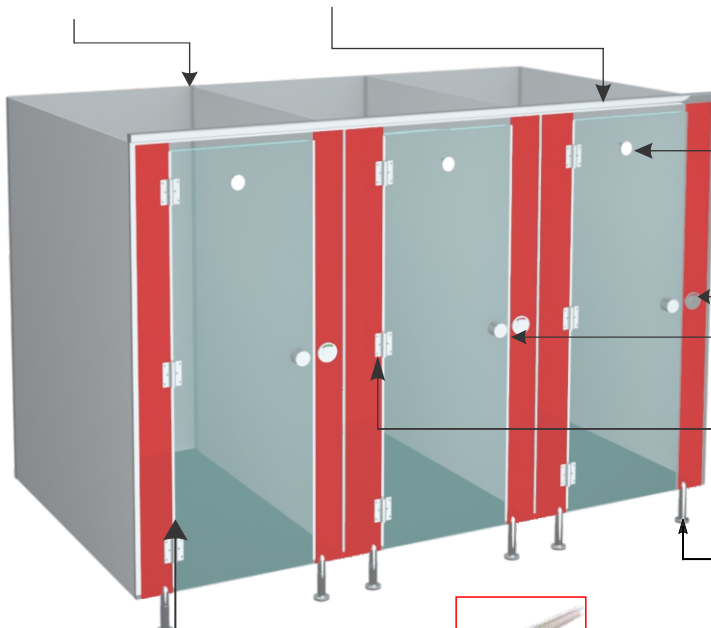

Stopper Channel



# RC - Smart Nylon



Nylon toilet cubicle system was created based on the very popular, for anyone who requires functional and economical solutions. The Nylon cubicle model is aesthetically designed with the extruded anodized aluminum top rail and polyamide hardware's, for giving a clean and a lean look to the restroom setup., which are durable and elegant, but also inexpensive. all pilasters as well as doors are 12 mm or 18mm thick with chamfered edges. The aesthetic finish of the boards as well as the anodized aluminum profiles attaching the cubicles to the fixed walls and fittings give the system a minimalistic appearance.



ADJUSTABLE LEG



INDICATOR LOCK



COAT HOOK



GRAVITY HINGES



DOOR KNOB

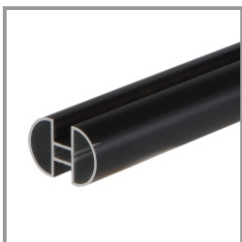

TOP RAIL (BLACK )  
POWDER COATED  
ALUMINIUM



U-CHANNEL (BLACK )  
POWDER COATED  
ALUMINIUM



DOOR STOPPER (BLACK )  
POWDER COATED  
ALUMINIUM



F-CHANNEL (BLACK )  
POWDER COATED  
ALUMINIUM

## Dimension Detailing

Standard Dimensions	General (mm)	Physically Challenged (mm)
Width of cubicle	1000	1500
Depth of cubicle	1500	1750
Height of entire cubicle	2035	2035
Width of door	600	900
Height of door	1785	1785
Ground clearance	150	150

Simple and strong with a durable elegance, Versatile Combo by Restcube is especially suited to change rooms and commercial bathrooms. This design maximizes privacy while offering strong, stylish lines and proven durability. Engineered with 12mm or 18mm thick high pressure Compact Laminate, this model comes with the combination of stainless steel hardware's with extruded anodized aluminum top rail and fixing channels. It can be manufactured to your own specifications in range of colours, materials for both



**ADJUSTABLE LEG**  
STAINLESS STEEL  
316 SS



**INDICATOR LOCK**  
STAINLESS STEEL  
304 SS



**COAT HOOK**  
STAINLESS STEEL  
304 SS



**GRAVITY HINGE**  
STAINLESS STEEL  
304 SS



**DOOR KNOB**  
STAINLESS STEEL  
304 SS



**U-CHANNEL (SILVER)**  
POWDER COATED  
ALUMINIUM



**DOOR STOPPER (SILVER)**  
POWDER COATED  
ALUMINIUM



**F-CHANNEL (SILVER)**  
POWDER COATED  
ALUMINIUM

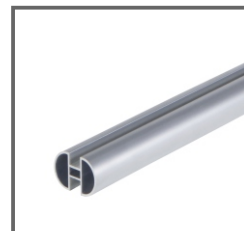

**TOP RAIL (SILVER)**  
POWDER COATED  
ALUMINIUM

## Dimension Detailing

Standard Dimensions	General (mm)	Physically Challenged (mm)
Width of cubicle	1000	1500
Depth of cubicle	1500	1750
Height of entire cubicle	2035	2035
Width of door	600	900
Height of door	1785	1785
Ground clearance	150	150

# RC - Dynamic - SS



Dynamic SS Toilet Partition one of our most popular styles over many years. The Pedestal mounted & braced system offers strength, durability and easy cleaning combined with fresh, clean lines and vibrant colour contrasts.

Available in a wide range of colours, materials and finishes for both shower and toilet cubicle construction, Dynamic SS features heavy duty head rail and channels, concealed fix pure SS 304 And 316 grade hardware for enhanced privacy.



**ADJUSTABLE LEG  
STAINLESS STEEL  
316 SS**



**INDICATOR LOCK  
STAINLESS STEEL  
304 SS**



**COAT HOOK  
STAINLESS STEEL  
304 SS**



**GRAVITY HINGE  
STAINLESS STEEL  
304 SS**



**DOOR KNOB  
STAINLESS STEEL  
304 SS**



**U-CHANNEL  
STAINLESS STEEL  
304 SS**



**DOOR STOPPER  
STAINLESS STEEL  
304 SS**



**F-CHANNEL  
STAINLESS STEEL  
304 SS**



**TOP RAIL  
STAINLESS STEEL  
304 SS**

## Dimension Detailing

Standard Dimensions	General (mm)	Physically Challenged (mm)
Width of cubicle	1000	1500
Depth of cubicle	1500	1750
Height of entire cubicle	1960	1960
Width of door	600	900
Height of door	1785	1785
Ground clearance	140	140

Titanium Shoe Box up Floor Mounted Braced system offers you the opportunity to combine durability with style, Available in a wide range of colours, materials and finishes for both shower and toilet cubicle construction, the Shoe Box series is floor mounted for maximum strength, and features Stainless steel 304 & 316, head rail and channels for heavy duty wearability, and an optional gapless rebate door for improved privacy. Rest of the hardware's like hinges, locks, door knobs and coat hooks are also produced in stainless steel. Thus, 12 mm or 18mm shoe box up model is the perfect selection for your restroom space designing.



**SHOE-BOX UP  
STAINLESS STEEL  
316 SS**



**WC-INDICATOR LOCK  
STAINLESS STEEL  
304 SS**



**COAT HOOK  
STAINLESS STEEL  
304 SS**



**GRAVITY HINGES  
STAINLESS STEEL  
304 SS**



**DOOR KNOB  
STAINLESS STEEL  
304 SS**



**U-CHANNEL  
STAINLESS STEEL  
304 SS**



**DOOR STOPER  
STAINLESS STEEL  
304 SS**



**F-CHANNEL  
STAINLESS STEEL  
304 SS**



**TOP RAIL  
STAINLESS STEEL  
304 SS**

## Dimension Detailing

Standard Dimensions	General (mm)	Physically Challenged (mm)
Width of cubicle	1000	1500
Depth of cubicle	1500	1750
Height of entire cubicle	2100	2100
Width of door	600	900
Height of door	1915	1915
Ground clearance	100	100

# RC-TITANIUM CEILING HUNGS



Add classic wings to your restrooms Innovation with simplicity and splendor, RestCube presents you Classique Wings, a sparkling new assortment of restroom cubicles. Planned under the blueprints of aesthetics, this ceiling hung model has been designed to further enhance the beauty of your washrooms, while creating desirable spaces. Its unique shape and profile provide ample space to wipe the floors easily and without any hassles. So, introduce these exclusive masterworks to your rest rooms and enrich your creations, the contemporary and classic way



**SHOE-BOX UP**  
STAINLESS STEEL  
316 SS



**WC-INDICATOR LOCK**  
STAINLESS STEEL  
304 SS



**COAT HOOK**  
STAINLESS STEEL  
304 SS



**GRAVITY HINGES**  
STAINLESS STEEL  
304 SS



**DOOR KNOB**  
STAINLESS STEEL  
304 SS



**U-CHANNEL**  
STAINLESS STEEL  
304 SS



**DOOR STOPER**  
STAINLESS STEEL  
304 SS



**F-CHANNEL**  
STAINLESS STEEL  
304 SS



**TOP RAIL**  
STAINLESS STEEL  
304 SS

## Dimension Detailing

Standard Dimensions	General (mm)	Physically Challenged (mm)
Width of cubicle	1000	1500
Depth of cubicle	1500	1750
Height of entire cubicle	1960	1960
Width of door	600	900
Height of door	1785	1785
Ground clearance	140	140

# EU-Enclosed Unit

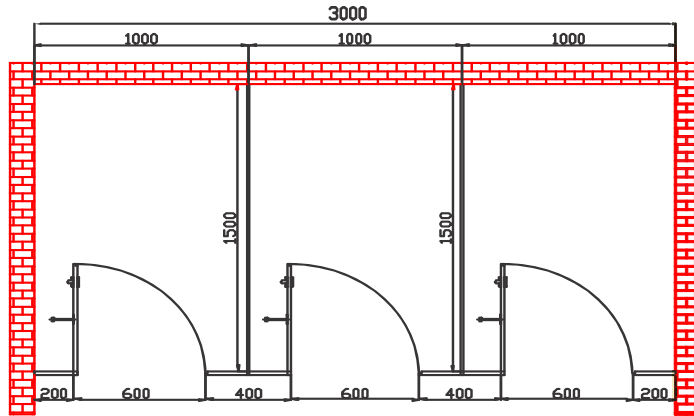

Top View (EU)

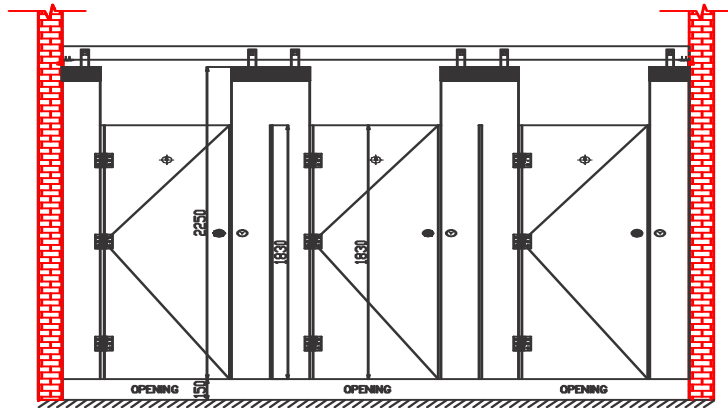

Front View (EU)



# RC - FLOUTER



CW Floppy are tailor-made for restrooms. These cubicles have a clear floor concept which is very friendly as far as the maintenance is concerned. These cubicles can be easily installed due to their contemporary designs. Their floater concept gives them a natural yet classic touch. To enhance the exquisiteness, all doors are 12 mm or 18mm thick and their stainless steel hardware fittings make these cubicles highly durable and longlasting. These cubicles are recommended for commercial complexes, sports clubs and gyms etc.



**SHOE-BOX UP**  
STAINLESS STEEL  
316 SS



**WC-INDICATOR LOCK**  
STAINLESS STEEL  
304 SS



**COAT HOOK**  
STAINLESS STEEL  
304 SS



**GRAVITY HINGES**  
STAINLESS STEEL  
304 SS



**DOOR KNOB**  
STAINLESS STEEL  
304 SS



**U-CHANNEL**  
STAINLESS STEEL  
304 SS



**DOOR STOPER**  
STAINLESS STEEL  
304 SS



**F-CHANNEL**  
STAINLESS STEEL  
304 SS



**TOP RAIL**  
STAINLESS STEEL  
304 SS

## Dimension Detailing

Standard Dimensions	General (mm)	Physically Challenged (mm)
Width of cubicle	1000	1500
Depth of cubicle	1500	1750
Height of entire cubicle	1960	1960
Width of door	600	900
Height of door	1785	1785
Ground clearance	140	140

# EU-Enclosed Unit

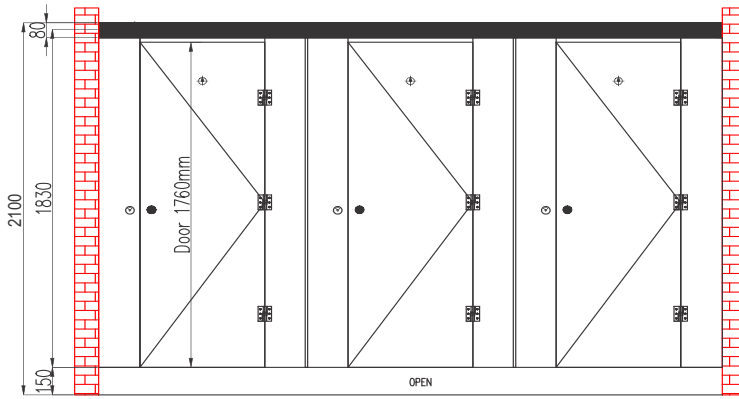

Front View (EU)

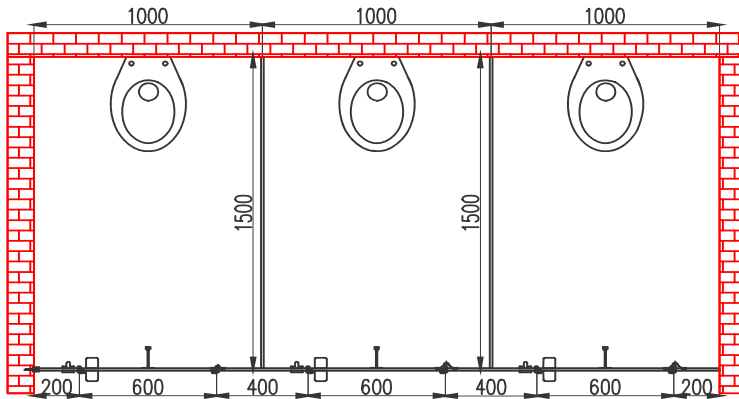

Top View (EU)



# RC - Pipe Glance



Simple yet contemporary is anonymous with SS Pipe Glance. The model comes with the most extensively used stainless steel hardware coupled with sturdiness of high pressure 12mm or 18mm Compact Laminate. It offers standard adjustable foot along with stainless steel top rail for providing extra strength. The rest of the hardware like the hinges, locks, door knobs and coat hooks are also provided in stainless steel. Hence, making it an elegant and ideal option for heavy traffic areas where functionality matters the most.



**ADJUSTABLE LEG  
STAINLESS STEEL  
316 SS**



**WC-INDICATOR LOCK  
STAINLESS STEEL  
304 SS**



**COAT HOOK  
STAINLESS STEEL  
304 SS**



**GRAVITY HINGES  
STAINLESS STEEL  
304 SS**



**DOOR KNOB  
STAINLESS STEEL  
304 SS**

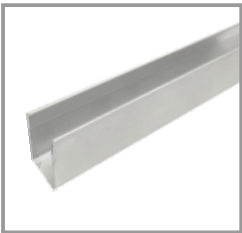

**U-CHANNEL  
STAINLESS STEEL  
304 SS**



**DOOR STOPPER  
STAINLESS STEEL  
304 SS**



**CORNER HOLDER  
STAINLESS STEEL  
304 SS**



**TOP RAIL  
STAINLESS STEEL  
304 SS**



**TUBULAR HOLDER  
STAINLESS STEEL  
304 SS**

## Dimension Detailing

Standard Dimensions	General (mm)	Physically Challenged (mm)
Width of cubicle	1000	1500
Depth of cubicle	1500	1750
Height of entire cubicle	1960	1960
Width of door	600	900
Height of door	1785	1785
Ground clearance	140	140

Nylon toilet cubicle system was created based on the very popular, for anyone who requires functional and economical solutions. The Nylon cubicle model is aesthetically designed with the extruded anodized aluminum top rail and polyamide hardware's, for giving a clean and a lean look to the restroom setup, which are durable and elegant, but also inexpensive. all pilasters as well as doors are 12 mm or 18mm thick with chamfered edges. The aesthetic finish of the boards as well as the anodized aluminum profiles attaching the cubicles to the fixed walls and fittings give the system a minimalistic appearance.



ADJUSTABLE LEG



INDICATOR LOCK



COAT HOOK



GRAVITY HINGES



DOOR KNOB



TOP RAIL (BLACK)  
POWDER COATED  
ALUMINIUM



U-CHANNEL (BLACK)  
POWDER COATED  
ALUMINIUM



DOOR STOPPER (BLACK)  
POWDER COATED  
ALUMINIUM



F-CHANNEL (BLACK)  
POWDER COATED  
ALUMINIUM

## EU-Enclosed Unit

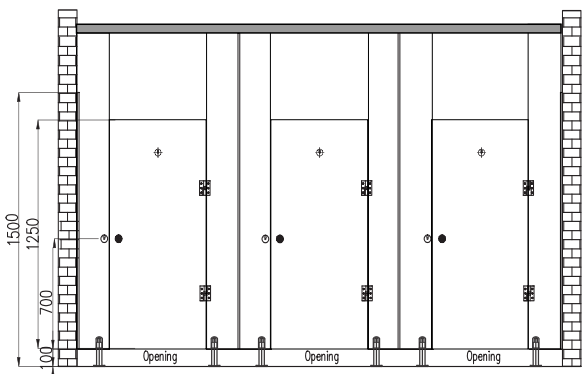

Front View

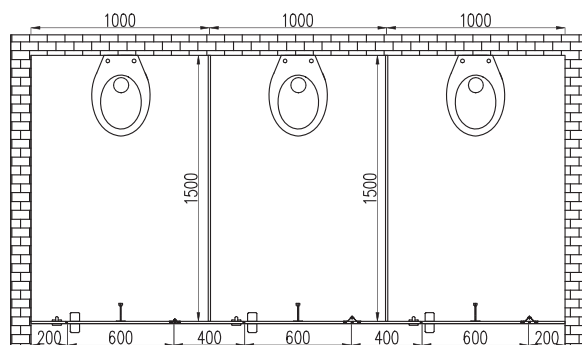

Top View



## Kids Series 1

Dimension Detailing		
Standard Dimensions	Width (mm)	Hight (mm)
Door	600	1200
Divider	1200	1800
Overall Cubicle	1000	1950

## Kids Series 2

Dimension Detailing		
Standard Dimensions	Width (mm)	Hight (mm)
Door	600	1200
Divider	1200	1200
Overall Cubicle	1000	1350



## Kids Series 3

Dimension Detailing		
Standard Dimensions	Width (mm)	Hight (mm)
Door	600	1750
Divider	1200	1750
Overall Cubicle	1000	2000

### Dimension Detailing

Standard Dimensions	General (mm)	Physically Challenged (mm)
Width of cubicle	1000	1500
Depth of cubicle	1500	1700
Height of divider	1200-1785	1200-1785
Height of entire cubicle	1500-2000	1500-2000
Width of door	600	900
Height of door	1250-1785	1250-1785
Ground clearance	100-150	100-150

# RC - PD Door

A combination of style and stability. Vibrancies' Splendid is ideal for renovation projects, using existing intermediate brick walls. With the usage of existing intermediate brick walls this model fits in perfectly as it suffices only the door requirements. Thus, Splendid replaces the traditionally used door setup with contemporary looking masonry walls. This model comes with a 12 mm or 18mm thick Compact Laminate doors in varied colors and designs along with aluminum and nylon polyamide (Grade 6) fittings



ADJUSTABLE LEG



INDICATOR LOCK



COAT HOOK



GRAVITY HINGES



DOOR KNOB



D-Poll Channel  
Black Anodize Aluminium

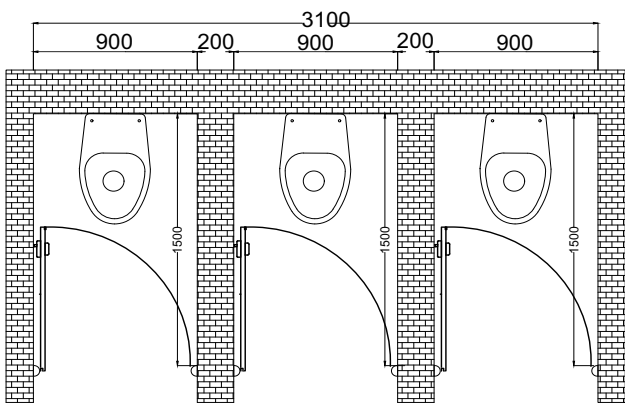

Top View (EU)

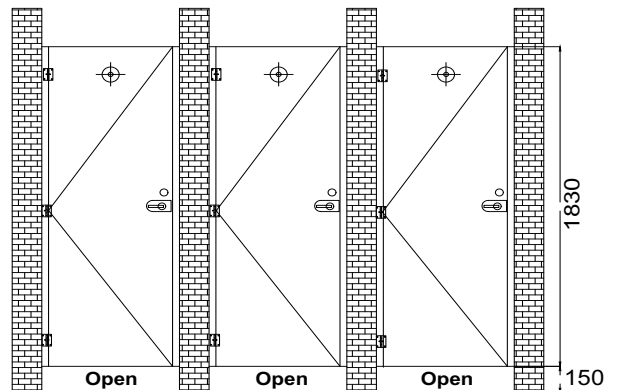

Front View (EU)

## Dimension Detailing

Standard Dimensions	General (mm)	Physically Challenged (mm)
Door Width of cubicle	600-900	As this model only uses door applications the dimensions for physically challenged setup will depend on the site's walls
Height of entire cubicle	1980	
Height of door	1830	
Ground clearance	150	150

# RC - UMP (Urinal Partition)



Urinal dividers ensure privacy in an open floor plan for washrooms. Also known as privacy screens, these are screens affixed in between the urinals to shield the visual and offer a sense of personal space. RestCube offers a plethora of options to browse through to find a match for your bathroom needs.



### Model A

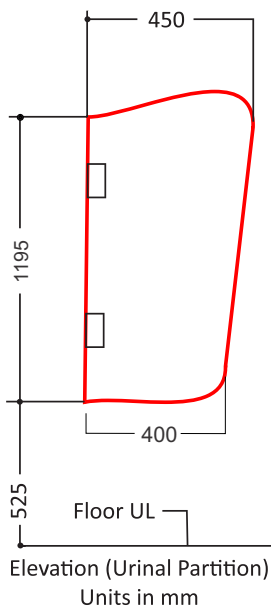

### Model B

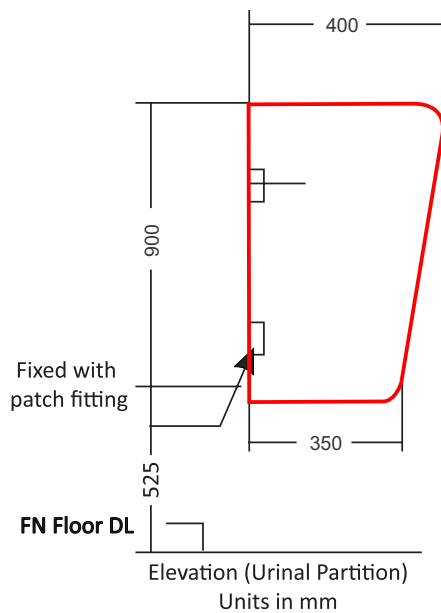

### Model C

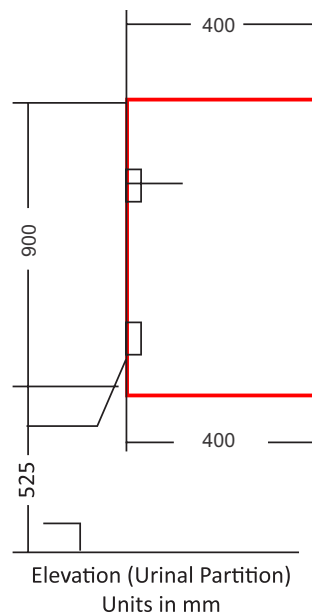

Stainless Steel L-Clamps

## Hardware Detailing

Each divider panel is equipped with the following hardware fittings:

- Stainless steel L-clamps is used to attach the divider to the wall

## Hardware Fixing Details

Stainless steel L-clamps hardware fittings along with SU-304 screws are used to fix the urinal partitions on the wall.



### High Pressed Laminate (HPL)

HPL Board Urinal Partition urinal partition are manufactured using 12 mm or 18mm thick Compact Laminates, cut & finish in different sizes, fixed on wall using SS 304 Heavy "L" Bracket with insert

### Frosted Glass

Chamfer Glass urinal partition: Made of 12mm thick heat strengthen glass with both side acid frost finish, cut & finish in different sizes, fixed on wall using SS 304 Heavy "L" Bracket with insert



### Dimension Detailing

Standard Dimensions	General (mm)
Height of Partition	900-1200
Depth	400-550
Gap from ground floor	500-600



CW lockers open up a new generation of locker rooms. A world of ultra-modern and exceptionally smart storage solutions made using CWP compact laminates.

Brilliant designed and widely durable, they are suitable for high humidity areas such as fitness clubs, sauna rooms, swimming pools, retail environments and sports centers.

Available in a wide range of styles, sizes, configurations and colors to achieve a perfect match with your services and interior designs. These systems are extra-tough, environment-friendly, easy to install and even easier to use.

What's more, they come with unique Anti-bacterial property that makes them a superb choice for hygiene concern areas.

### Key Highlight

- Made using Anti-bacterial compact laminates (3mm to 9mm)
- Made using heavy duty Stainless Steel channel
- Provision of 3 locking systems
  - Customer lock
  - Inbuilt lock
  - Keyless lock
- Comes with an option of different base mechanism
  - Stainless Steel leg base
  - Compact Laminates base
  - Concrete base

## 1 Tier Locker

Dimension Detailing	
Standard Dimensions	Size (mm)
Width of locker	300
Depth of Locker	450
Height of Locker	1800



## 2 Tier Locker



Dimension Detailing	
Standard Dimensions	Size (mm)
Width of locker	300
Depth of Locker	450
Height of Locker	895

## 3 Tier Locker

Dimension Detailing	
Standard Dimensions	Size (mm)
Width of locker	300
Depth of Locker	450
Height of Locker	594



## 4 Tier Locker



Dimension Detailing	
Standard Dimensions	Size (mm)
Width of locker	300
Depth of Locker	450
Height of Locker	443

# Our Valued Customer



# Color Shades



**RC-Super White**  
AT-1101 SD



**RC-Frosty White**  
AT-1103 SD

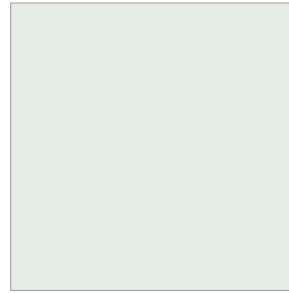

**RC-Silver Grey**  
AT-1104 SD



**RC-Black**  
AT-1106 SD



**RC-Cardinal Red**  
AT-1107 SD



**RC-Marigold Yellow** (PM)  
AT-1108 SD



**RC-Electric Blue** (PM)  
AT-1109 SD

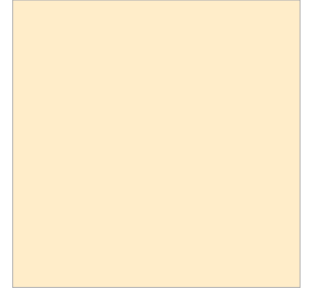

**RC-Ivory** (PM)  
AT-1111 SD



**RC-Gothic Grey**  
AT-1113 SD

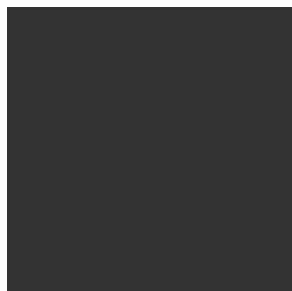

**RC-Slate Grey**  
AT-1105 SD



**RC-Orange**  
AT-1116 SD

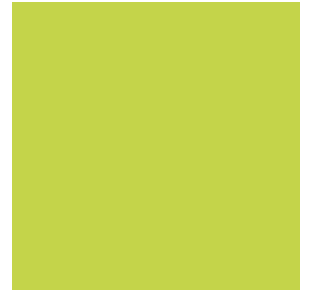

**RC-Parrot Green**  
AT-1119 SD



**RC-Natural Teak** (PM)  
AT-3001 SD



**RC-Straight Grained Wenge** (PM)  
AT-3008 SD



**RC-Classic Planked Walnut** (PM)  
AT-3009 SD



**RC-Inntel Beach** (PM)  
AT-3016 SD



**RC-Oxford Cherry** (PM)  
AT-3022 SD



**RC-Alberta Maple** (P)  
AT-3023 SD



**RC-Bavarian Beech** (PM)  
AT-3027 SD



**RC-Elegant Teak** (PM)  
AT-3041 SD



## Get In Touch

 +91 7738877661

 [www.restcube.in](http://www.restcube.in)

 [info@restcube.in](mailto:info@restcube.in)

### **Office Address**

4/38, Indira Krupa, Siddharth  
Nagar, Bandra, East  
Mumbai 400051

### **WareHouse**

R. NO. 01, Sitaram Gupta Chawl,  
SHARMAWADI, SANTOSH  
BHAVAN, Nallasopara East,  
Vasai Virar, Palghar,  
Maharashtra, 401209



# RestCube

Quality with assurance  
provide unexpectable service